



特点

- 国际标准封装，芯片与底板电气绝缘耐压 3000V
- 采用进口玻璃钝化芯片焊接式结构，优良的温度特性和功率循环能力
- 350A以下模块皆为强迫风冷，400A以上模块，风冷，水冷选用

典型应用

- 直流电源，各种稳压电源
- 工业加热控制
- 电机软起动，整流电源
- 变频器，充电机，电池充放电

IT(AV)	56A
VDRM/VRRM	600-2400V
ITSM	1.3 KA
I ² _t	8.6 10 ³ a ² s

符号	参数	测试条件	结温 T _J (°C)	参数值			单位
				最小	典型	最大	
I _{F(AV)}	正向平均电流	180° 正弦半波, 50HZ 单面散热, T _C =100°C	150		56	60	A
I _{F(RMS)}	方均根电流		150			86	A
V _{RRM}	反向重复峰值电压	V _{RRM} tp=10ms V _{RSM} =V _{RRM} +200V	150		1600		V
I _{RRM}	反向重复峰值电流	V _{RM} =V _{RRM}	150			5	mA
I _{FSM}	正向不重复浪涌电流	10ms底宽, 正弦半波 V _R =0.6V _{RRM}	150			1.3	KA
I ² _t	浪涌电流平方时间积					8.6	A ² S*10 ³
V _{FO}	门槛电压		150			0.80	V
r _F	斜率电阻					3.47	mΩ
V _{FM}	正向峰值电压	I _{FM} =168A	25			1.1	V
R _{th(j-c)}	热阻抗(结至壳)	180° 正弦波, 单面散热				0.48	°C/W
R _{th(c-h)}	热阻抗(壳至散)	180° 正弦波, 单面散热				0.2	°C/W
V _{iso}	绝缘电压	50Hz,R.M.S,t=1min,I _{iso} :1mA(max)			3000		V
F _M	安装扭矩(M5)				3		N-m
	安装扭矩(M6)				4		N-m
T _{stq}	储存温度			-40		125	°C
W _t	质量						g
Outline	外形	92 X 20mm					

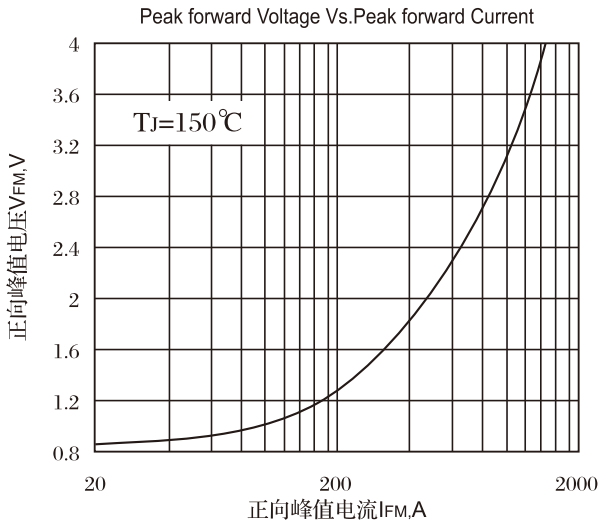

Fig.1 正向伏安特性曲线

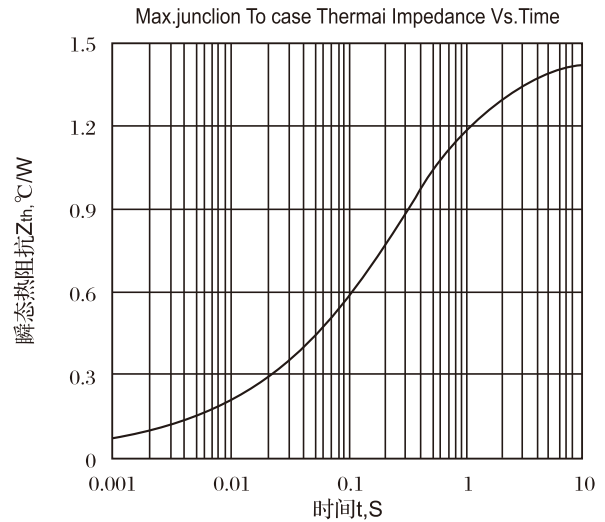

Fig.2 瞬态热阻抗曲线

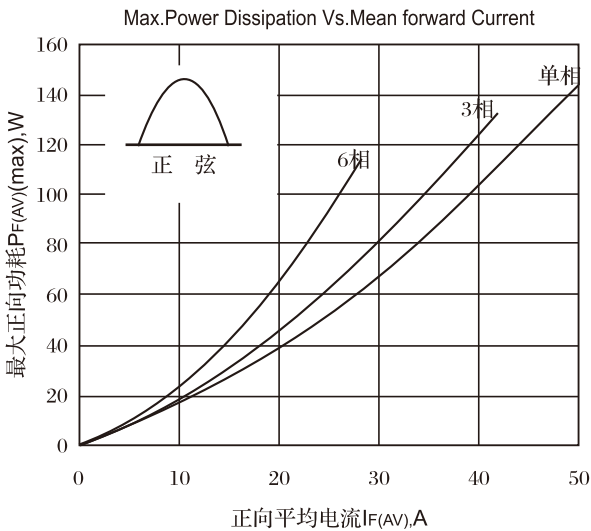

Fig.3 最大正向功耗与平均电流关系曲线

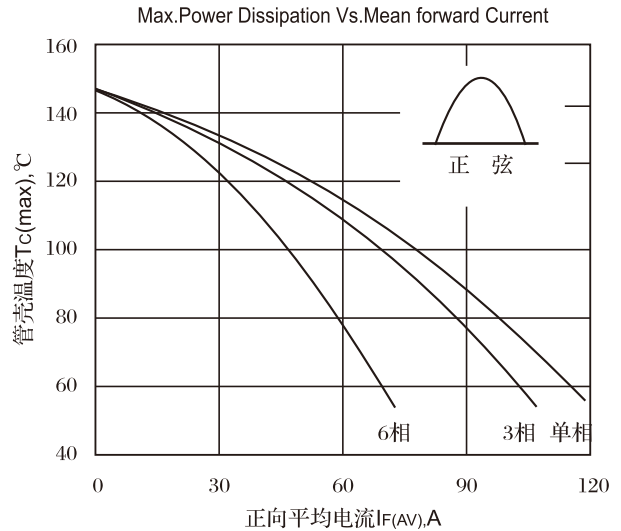

Fig.4 管壳温度与正向平均电流关系曲线

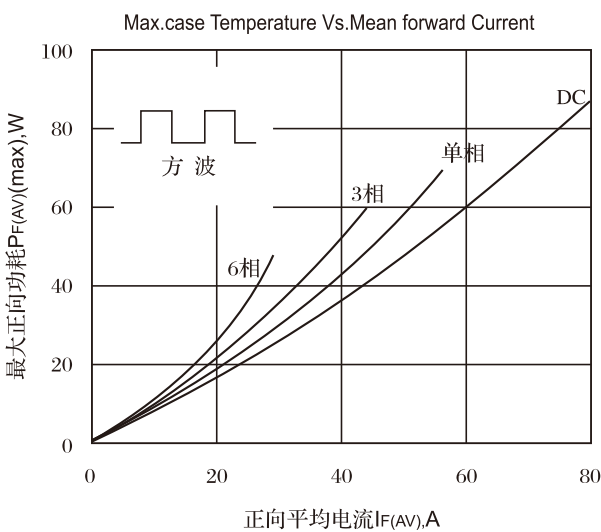

Fig.5 最大正向功耗与平均电流关系曲线

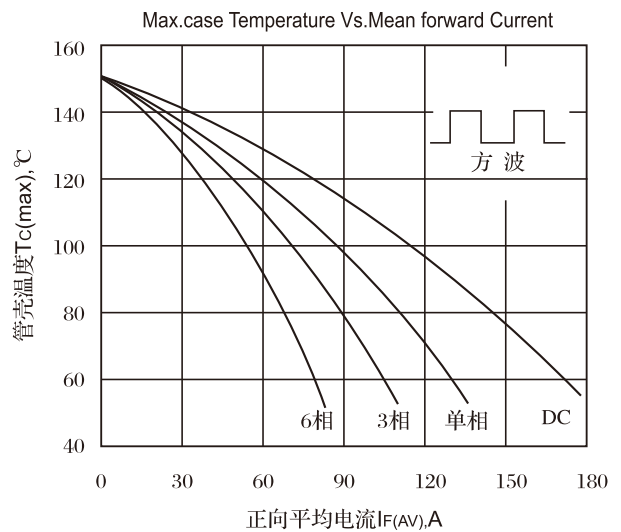

Fig.6 管壳温度与正向平均电流关系曲线

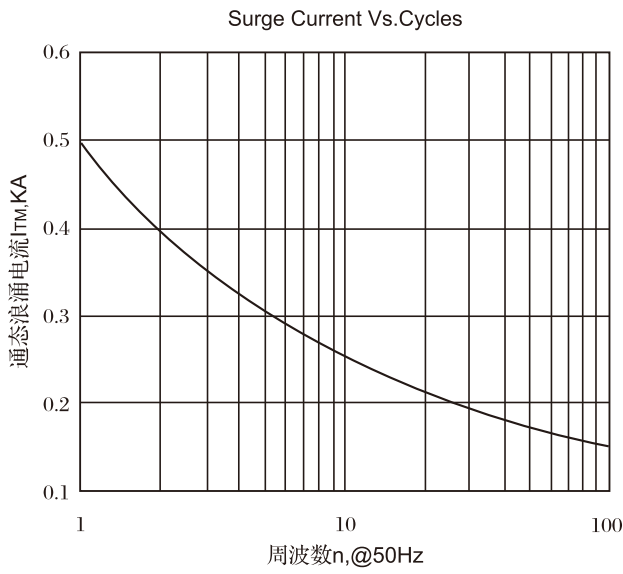

Fig.7 通态浪涌电流与周波数的关系曲线

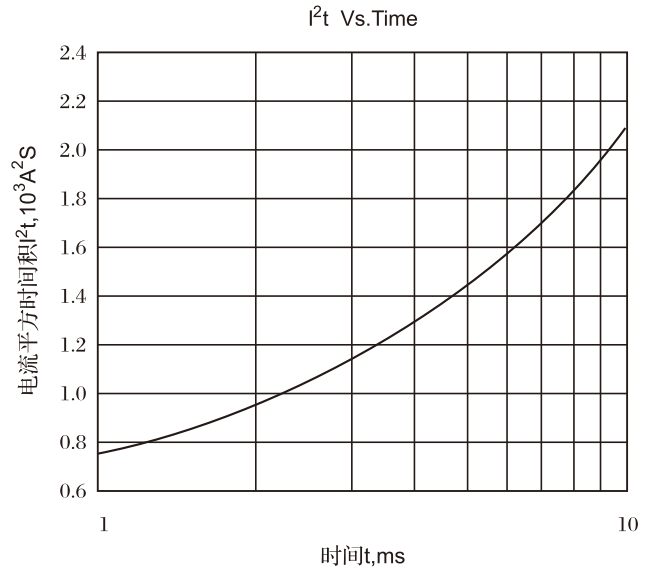
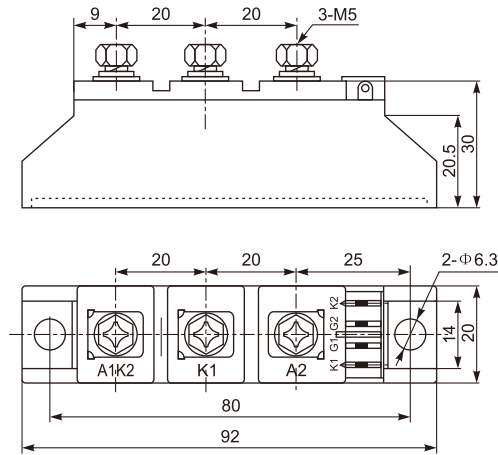

Fig.8 I²t 特性曲线

外形图:



线路图:

